

Surname	Centre Number	Candidate Number
First name(s)		0



GCSE

3300U40-1



WEDNESDAY, 14 JUNE 2023 – MORNING

**MATHEMATICS
UNIT 2: CALCULATOR-ALLOWED
INTERMEDIATE TIER**

1 hour 45 minutes

ADDITIONAL MATERIALS

A calculator will be required for this examination.
A ruler, protractor and a pair of compasses may be required.

INSTRUCTIONS TO CANDIDATES

Use black ink or black ball-point pen. Do not use gel pen or correction fluid.

You may use a pencil for graphs and diagrams only.

Write your name, centre number and candidate number in the spaces at the top of this page.

Answer **all** the questions in the spaces provided.

If you run out of space, use the additional page at the back of the booklet. Question numbers must be given for all work written on the additional page.

Take π as 3.14 or use the π button on your calculator.

INFORMATION FOR CANDIDATES

You should give details of your method of solution when appropriate.

Unless stated, diagrams are not drawn to scale.

Scale drawing solutions will not be acceptable where you are asked to calculate.

The number of marks is given in brackets at the end of each question or part-question.

In question **8**, the assessment will take into account the quality of your linguistic and mathematical organisation, communication and accuracy in writing.

For Examiner's use only		
Question	Maximum Mark	Mark Awarded
1.	4	
2.	4	
3.	3	
4.	4	
5.	5	
6.	3	
7.	2	
8.	7	
9.	3	
10.	5	
11.	6	
12.	4	
13.	4	
14.	6	
15.	7	
16.	4	
17.	4	
18.	5	
Total	80	

3300U401
01



JUN233300U40101

Formula List – Intermediate Tier

Area of trapezium = $\frac{1}{2}(a + b)h$

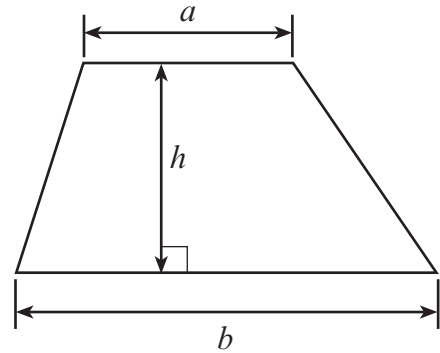

Volume of prism = area of cross-section \times length

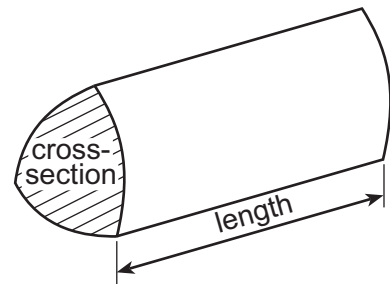

1. (a)

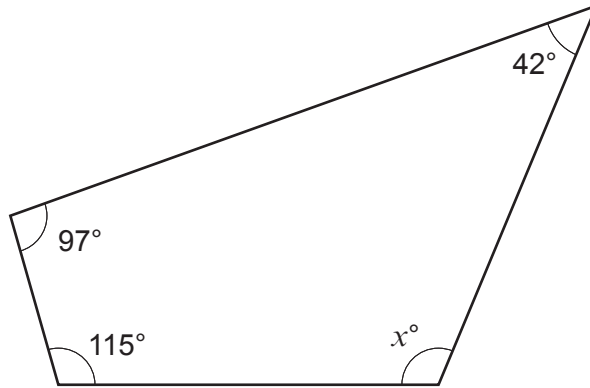
*Diagram not drawn to scale*Calculate the value of x .

[2]

.....

.....

.....

.....

(b) The diagram below shows an isosceles triangle.

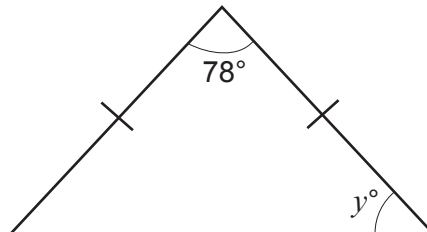
*Diagram not drawn to scale*Calculate the value of y .

[2]

.....

.....

.....

.....

.....



2. (a) Which **one** of the following fractions can be written as a recurring decimal?
Circle your answer. [1]

$\frac{1}{2}$

$\frac{1}{4}$

$\frac{1}{6}$

$\frac{1}{8}$

$\frac{1}{10}$

.....

.....

- (b) Which **three** numbers from the list below are prime numbers? [2]

27 31 35 39 43 47 51 55

The three prime numbers are:

....., and

(c) $81 = 3^n$.

Write down the value of n .

[1]

.....

.....

$n =$



- 3. Alice is 9 years younger than Isaac.
Nadia is one third of Isaac's age.
Dewi is twice Nadia's age.

Alice is 27 years old.

What are the ages of Isaac, Nadia and Dewi?

[3]

.....

.....

.....

.....

.....

.....

.....

.....

.....

Isaac is years old. Nadia is years old. Dewi is years old.

- 4. (a) Write down the next two numbers in the following sequence.

[2]

-26 -20 -14 -8

.....

.....

.....

(b) $f = 3g + 2h$.

Calculate the value of f when $g = 9.3$ and $h = -13.6$.

[2]

.....

.....

.....

.....

3300U401
05



5. (a) A box contains different-coloured balls.
Some are red, some are blue and the others are green.

The bar chart shows how many balls of each colour are in the box.

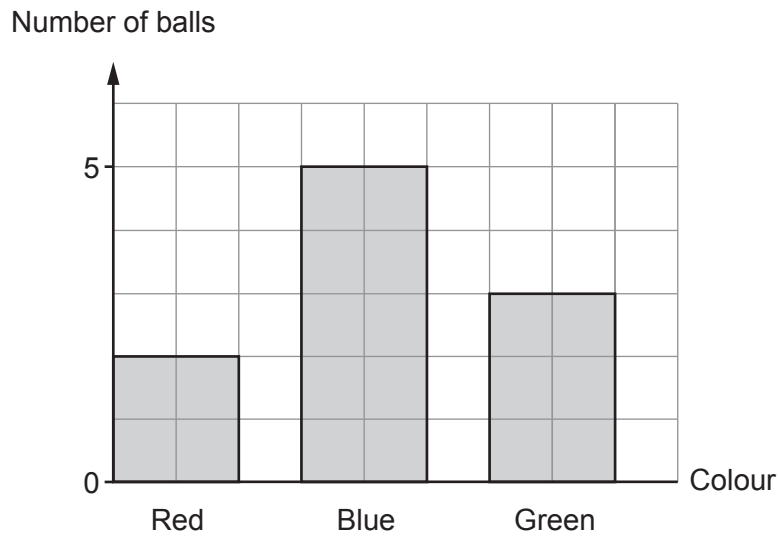

Draw an accurate pie chart to compare the number of coloured balls in the box.
Part of the pie chart has been completed for you.

[3]

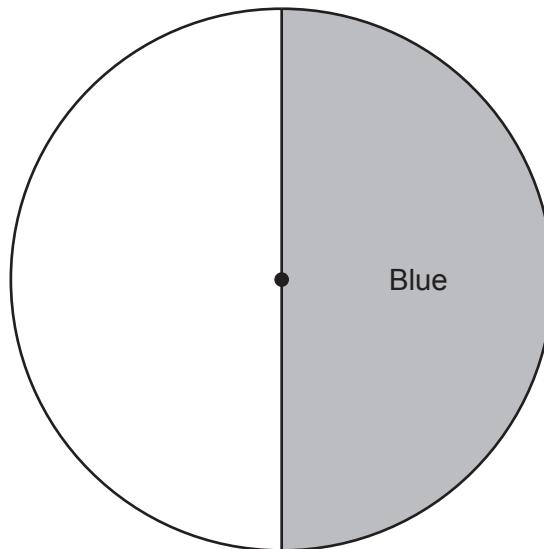

.....

.....

.....

.....



(b) The letters **A**, **B**, **C** and **D** describe four different events.

Experiment	Event	
A fair 6-sided dice is thrown.	A	4 is thrown.
A fair coin is thrown.	B	A tail is thrown.
Four cards labelled North, East, South and West are placed in a box. One card is chosen at random.	C	North is chosen.
Seven cards, each labelled with a different day of the week, are placed in a box. One card is chosen at random.	D	Sunday is chosen.

Using the letters **A**, **B**, **C** and **D**, list the events in the order of how likely they are to happen.

Start with the least likely and end with the most likely.

[2]

.....

.....

.....

.....

.....

.....

.....

.....

--	--	--	--

Least likely $\xrightarrow{\hspace{15em}}$ Most likely



6. A journey of 45 miles is travelled in 1 hour 15 minutes.
Calculate the average speed of this journey.
Give your answer in mph.

[3]

.....

.....

.....

.....

.....

.....

7. A regular polygon has 15 sides.
Calculate the size of an exterior angle of this regular polygon.

[2]

.....

.....

.....

.....

.....

.....

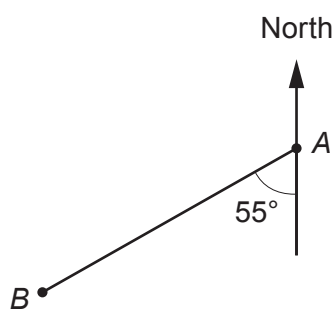

9. (a)

*Diagram not drawn to scale*(i) What is the bearing of point *B* from point *A*? [1]

.....

(ii) What is the bearing of point *A* from point *B*? [1]

.....

(b) Points *P*, *Q*, *R* and *S* are all 5 km from point *X*.*P* is on a bearing of 005° from *X*.*Q* is on a bearing of 100° from *X*.*R* is on a bearing of 240° from *X*.*S* is on a bearing of 355° from *X*.Which **two** of the four points *P*, *Q*, *R* and *S* are closest to each other? [1]Space for sketch

The two points closest to each other are and



10. A bus going to a *Welsh Heritage* conference has 43 people on board. There are 38 students, 4 tutors and a driver on the bus.

At the conference, each student will attend a session on *Language*, a session on *History* or both sessions.

- All the students will attend at least one session.
- 18 students will attend both sessions.
- 25 students will attend the session on *History*.
- The tutors and driver will not attend either of the sessions.

(a) Complete the Venn diagram below to show this information. The universal set, \mathcal{E} , contains all of the 43 people on the bus.

[3]

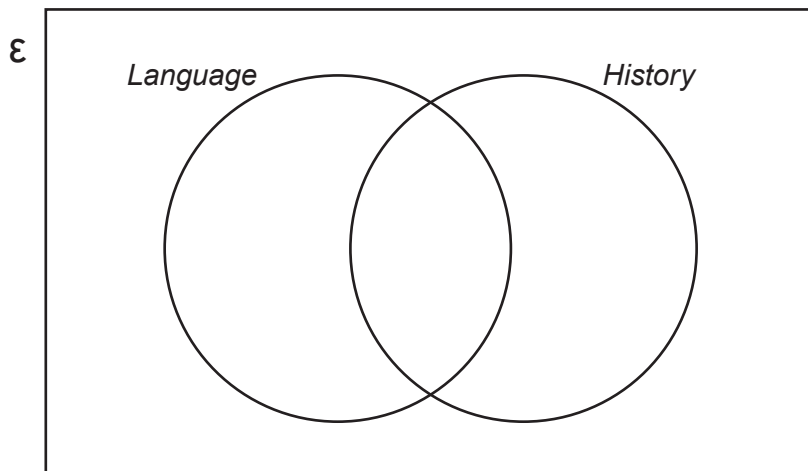

.....

.....

.....

.....

(b) One of the people on the bus is chosen at random. What is the probability that this person will attend the session on *Language*?

[2]

.....

.....

.....

.....



11. (a) Solve the equation $7 + 5(x - 2) = 3x + 8$.

[3]

.....

.....

.....

.....

.....

.....

(b) Make f the subject of the formula $h = 13 - 2f$.

[2]

.....

.....

.....

.....

(c) Factorise $15x - 35y$.

[1]

.....

.....



12. A large number of prize tokens are placed in a box.
The tokens are identical in shape and size.

Gold, Silver, Bronze or *No Prize* is written on each token.

One token is chosen at random from the box.

The table below shows the probability of choosing a *Gold* prize token and the probability of choosing a *Silver* prize token.

Token	Gold	Silver	Bronze	No Prize
Probability	0.02	0.18		

- (a) There are three times as many *No Prize* tokens in the box as there are *Bronze* prize tokens.

Complete the table.

[2]

.....

.....

.....

.....

.....

- (b) There are 15 *Gold* prize tokens in the box.
How many *Silver* prize tokens are there in the box?

[2]

.....

.....

.....

.....

.....



14. (a) Evaluate $\frac{\sqrt[3]{154}}{7.9 - 3.26}$.

Give your answer correct to 2 significant figures.

[2]

.....

.....

.....

.....

(b) Calculate the reciprocal of 23.
Give your answer correct to 3 decimal places.

[2]

.....

.....

.....

(c) Circle the correct answer for each of the following.

(i) The Lowest Common Multiple (LCM) of 4 and 6 is:

2 4 6 12 24

[1]

.....

(ii) The Highest Common Factor (HCF) of 10 and 15 is:

5 10 15 30 150

[1]

.....



